

V-TAC

Meaningful Innovation.

WEEE Number: 80133970

INSTRUCTION MANUAL

GARDEN SPIKE LAMP OUTDOOR SERIES



IP65
RATING

03 YEAR
WARRANTY*

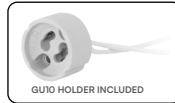

TECHNICAL DATA

MODEL	VT-1126
SKU	10373
RATED LOAD	35W
BASE	GU10 (Bulb not included)
MATERIAL	Aluminium
DIMENSION	Φ75x106x245mm
INPUT VOLTAGE	AC: 220-240V, 50Hz

INTRODUCTION

Thank you for selecting and buying V-TAC product. V-TAC will serve you the best. Please read these instructions carefully before starting the installation and keep this manual handy for future reference. If you have any another query, please contact our dealer or local vendor from whom you have purchased the product. They are trained and ready to serve you at the best. The warranty is valid for 3 years from the date of purchase. The warranty does not apply to damage caused by incorrect installation or abnormal wear and tear. The company gives no warranty against damage to any surface due to incorrect removal and installation of the product. The products are suitable for 10-12 Hours Daily operation. Usage of product for 24 Hours a day would void the warranty. This product is warranted for manufacturing defects only.

WARNING!

1. Please make sure to turn off the power before starting the installation.
2. Installation should only be done by a certified electrician.
3. Proper grounding should be ensured throughout the installation.
4. Waterproof Box not included.



This marking indicates that this product should not be disposed of with other household wastes.



Caution, risk of electric shock.

RoHS



INSTALLATION DIAGRAM:

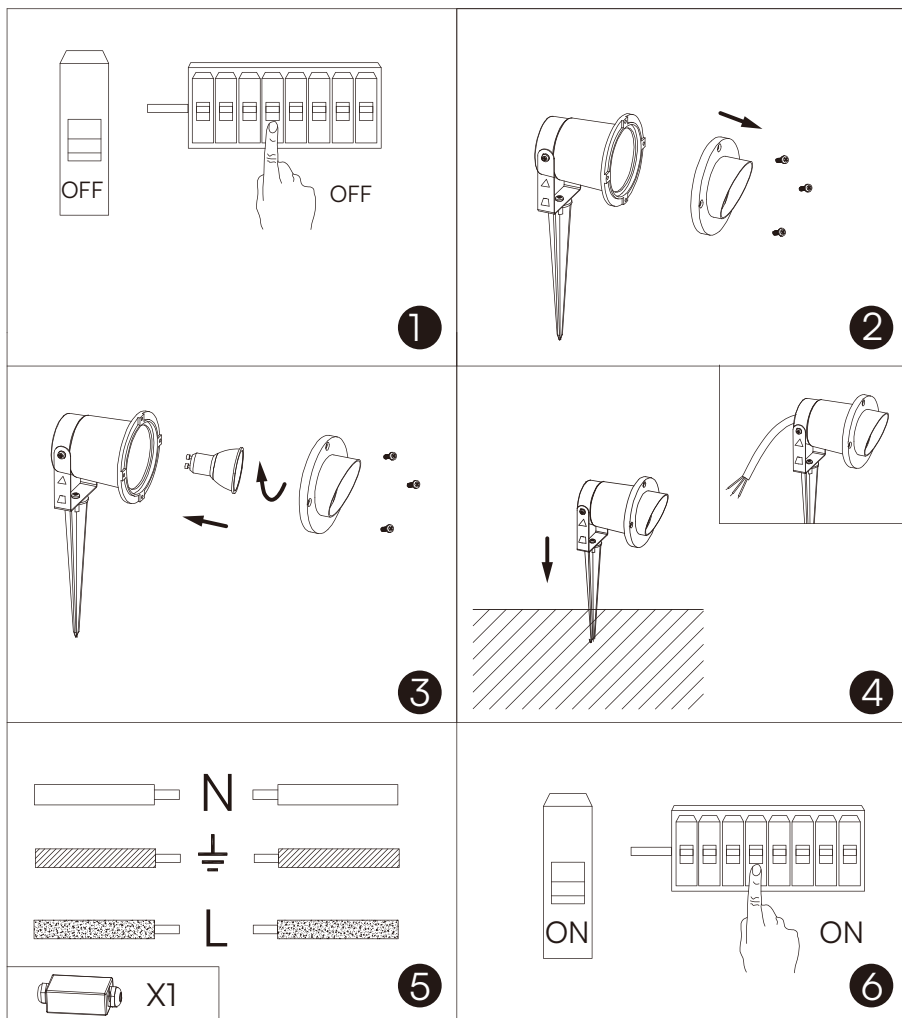

INSTALLATION INSTRUCTION

- Turn off the power switch.
- Remove the front ring of the lamp.
- Install the light source (GU10).
- Assemble the lamps and lanterns.
- Connect to the power supply according to the drawing.
- Switch on the power if above steps are done properly without any mistakes.

V-TAC

Meaningful Innovation.

WEEE Number: 80133970

РЪКОВОДСТВО ЗА УПОТРЕБА ГРАДИНСКА ЛАМПА С ШИПОВЕ НА ОТКРИТО

ТЕХНИЧЕСКИ ДАННИ

МОДЕЛ	VT-1126
SKU	10373
НАТОВАРВАНЕ С НОМИНАЛНА СТОЙНОСТ	35W
БАЗА	GU10 (крушката не е включена)
МАТЕРИАЛ	Алуминий
РАЗМЕР	Ф75x106x245mm
ВХОДНО НАПРЕЖЕНИЕ	Променлив ток: 220-240 V, 50 Hz



IP65
RATING

03 YEAR
WARRANTY



ВЪВЕДЕНИЕ

Благодарим ви, че избрахте и закупихте продукт на V-TAC. V-TAC ще ви служи по най-добрия начин. Моля, прочетете внимателно тези инструкции

преди започване на монтажа и съхранявайте това ръководство за бъдещи справки. Ако имате някакви други въпроси, моля, свържете се с нашия дилър или с местния продавач, от когото сте закупили продукта. Те са обучени и са готови да ви обслужат по най-добрия начин. Гаранцията е валидна за срок от 3 години от датата на закупуване. Гаранцията не важи за повреди, причинени от неправилен монтаж или необичайно износване. Фирмата не дава гаранция за повреди на повърхности, дължащи се на неправилно демонтиране и инсталиране на продукта. Продуктите са подходящи за 10-12-часова ежедневна работа. Използването на продукта в продължение на 24 часа на ден води до отпадане на гаранцията. Този продукт има гаранция само за производствени дефекти.

ПРЕДУПРЕЖДЕНИЕ!

- Моля, уверете се, че сте изключили захранването, преди да започнете монтажа.
- Монтажът трябва да се извършва само от сертифициран електротехник.
- По време на инсталацията трябва да се осигури правилно заземяване.
- Не е включена водоустойчива кутия.



Тази маркировка показва, че този продукт не трябва да се изхвърля заедно с други битови отпадъци.



Внимание, риск от електрически удар.

RoHS



МОНТАЖНА СХЕМА:

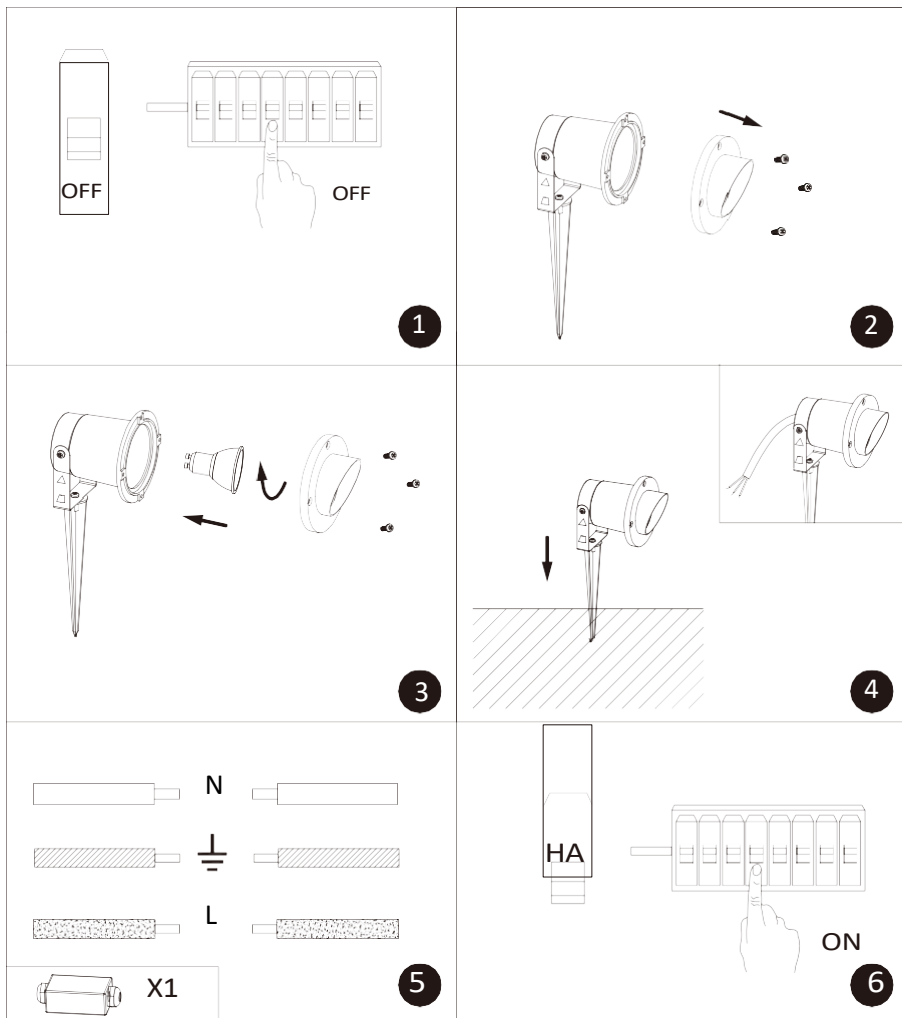

ИНСТРУКЦИЯ ЗА ИНСТАЛИРАНЕ

- Изключете превключателя на захранването.
- Свалете предния пръстен на лампата.
- Монтирайте източника на светлина (GU10).
- Сглобете лампите и фенерите.
- Свържете към захранването съгласно чертежа.
- Включете захранването, ако горните стъпки са изпълнени правилно и без грешки.

V-TAC

Meaningful Innovation.

WEEE Number: 80133970

UPUTE ZA UPORABU

SERIJA VRTNE SVJETILJKE S ŠILJKOM OUTDOOR

TEHNIČKI PODACI

MODEL	VT-1126
SKU	10373
NAZIVNO OPTEREĆENJE	35W
BAZA	GU10 (žarulja nije uključena)
MATERIJAL	Aluminij
DIMENZIJA	Φ75x106x245mm
ULAZNI NAPON	AC: 220-240V, 50Hz



IP65
RATING

03
YEAR
WARRANTY*



UVOD

Hvala što ste odabrali i kupili V-TAC proizvod. V-TAC će vam poslužiti najbolje. Pažljivo pročitajte ove upute prije početka instalacije i čuvajte ovaj priručnik pri ruci za buduće potrebe. Ako imate bilo kakvih dodatnih pitanja, obratite se našem trgovcu ili lokalnom prodavaču od kojeg ste kupili proizvod. Oni su obučeni i spremni poslužiti vas na najbolji način. Jamstvo vrijedi 3 godine od datuma kupnje. Jamstvo se ne odnosi na oštećenja uzrokovana neispravnom ugradnjom ili nenormalnim trošenjem. Tvrtka ne daje jamstvo protiv oštećenja bilo koje površine uslijed nepravilnog uklanjanja i postavljanja proizvoda. Proizvodi su prikladni za 10-12 sati dnevnog rada. Korištenje proizvoda 24 sata dnevno poništilo bi jamstvo. Ovaj proizvod ima jamstvo samo za greške nastale u proizvodnji.

UPOZORENJE!

1. Provjerite jeste li isključili napajanje prije početka instalacije.
2. Instalaciju smije izvesti samo ovlašteni električar.
3. Tijekom cijele instalacije potrebno je osigurati ispravno uzemljenje.
4. Vodootporna kutija nije uključena.



Ova oznaka označava da se ovaj proizvod ne smije odlagati s drugim kućnim otpadom.



Oprez, opasnost od strujnog udara.

RoHS



UK
CA

DIJAGRAM UGRADNJE:

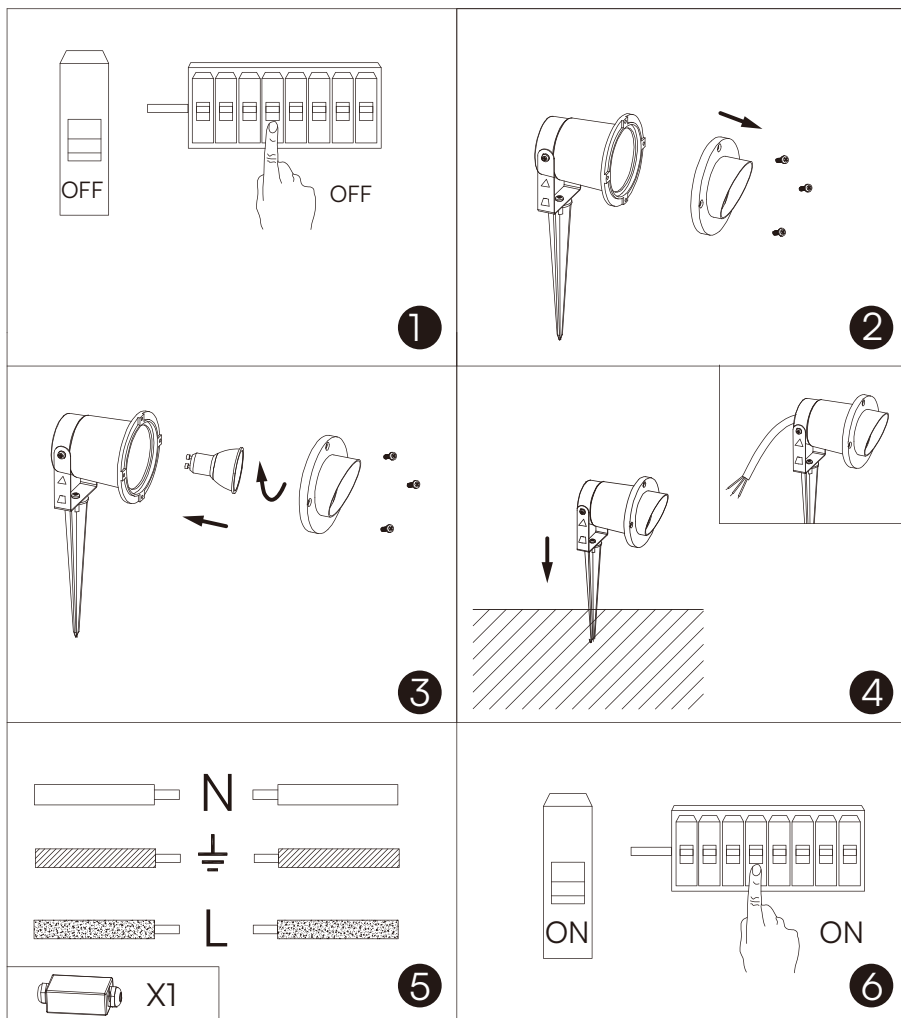

UPUTE ZA MONTAŽU

- Isključite prekidač napajanja.
- Uklonite prednji prsten svjetiljke.
- Instalirajte izvor svjetla (GU10).
- Sastavite svjetiljke i svjetiljke.
- Spojite na napajanje prema crtežu.
- Uključite napajanje ako ste gore navedene korake pravilno izvršili bez grešaka.

V-TAC

Meaningful Innovation.

WEEE Number: 80133970

NÁVOD K POUŽITÍ

ZAHRADNÍ BODOVÁ LAMPA VENKOVNÍ SÉRIE

TECHNICKÉ ÚDAJE

MODEL	VT-1126
SKU	10373
JMENOVIŤE ZATÍŽENÍ	35W
BASE	GU10 (žárovka není součástí dodávky)
MATERIÁL	Hliník
DIMENSION	Ø75x106x245mm
VSTUPNÍ NAPĚTÍ	AC: 220-240 V, 50 Hz



IP65
RATING

03 YEAR
WARRANTY*



ÚVOD

Děkujeme, že jste si vybrali a zakoupili produkt V-TAC. V-TAC vám bude sloužit co nejlépe. Přečtěte si prosím pozorně tyto pokyny

před zahájením instalace a uschovejte tento návod pro budoucí použití. V případě dalších dotazů se obraťte na našeho prodejce nebo místního prodejce, od kterého jste výrobek zakoupili. Jsou vyškoleni a připraveni vám co nejlépe posloužit. Záruka je platná po dobu 3 let od data zakoupení. Záruka se nevztahuje na poškození způsobené nesprávnou instalací nebo abnormálním opotřebením. Společnost neposkytuje záruku na poškození jakéhokoliv povrchu v důsledku nesprávné demontáže a instalace výrobku. Výrobky jsou vhodné pro 10-12 hodin denního provozu. Používání výrobku po dobu 24 hodin denně by znamenalo ztrátu záruky. Na tento výrobek se vztahuje záruka pouze na výrobní vady.

POZOR!

1. Před zahájením instalace nezapomeňte vypnout napájení.
2. Instalaci by měl provádět pouze certifikovaný elektrikář.
3. Správné uzemnění by mělo být zajištěno v celé instalaci.
4. Vodotěsný box není součástí dodávky.



Toto označení znamená, že tento výrobek by neměl být likvidován společně s ostatními odpady z domácnosti.



Pozor, nebezpečí úrazu elektrickým proudem.

RoHS



INSTALAČNÍ SCHÉMA:

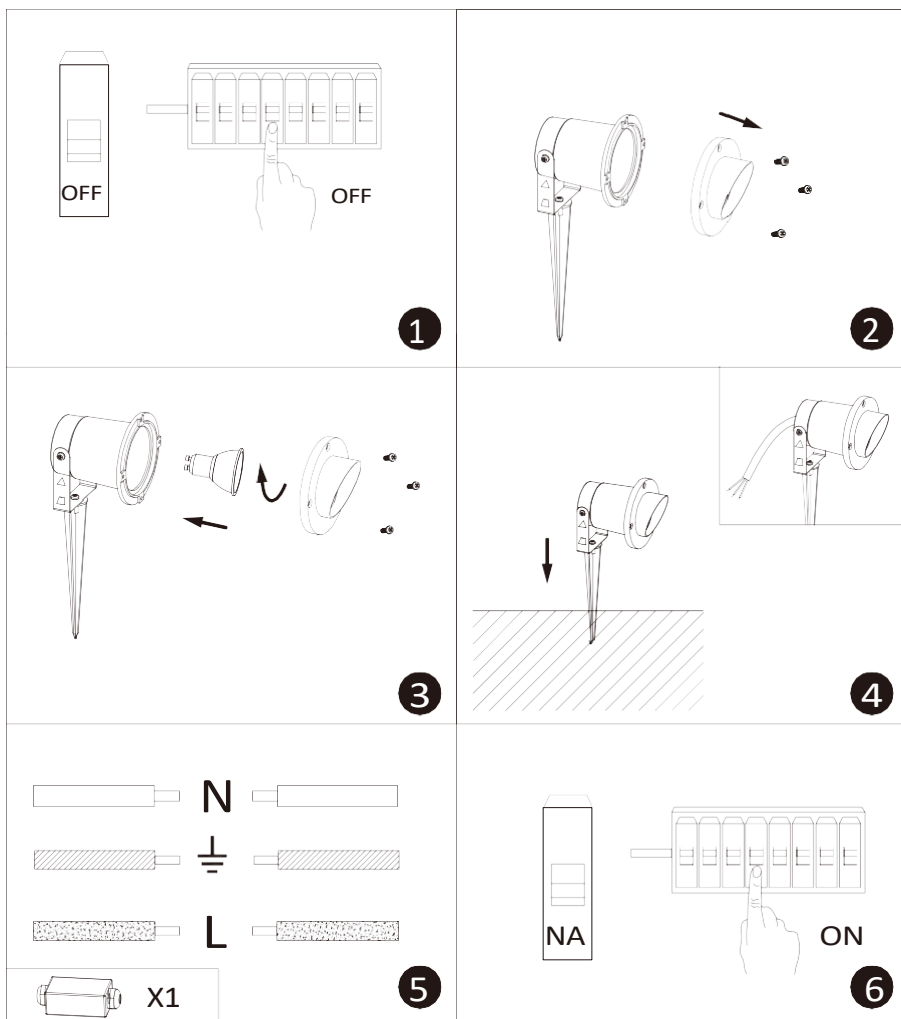

NÁVOD K INSTALACI

- Vypněte vypínač.
- Sejměte přední kroužek svítily.
- Nainstalujte zdroj světla (GU10).
- Sestavte lampy a lucerny.
- Připojte se k napájení podle výkresu.
- Pokud jsou výše uvedené kroky provedeny správně a bez chyb, zapněte napájení.

V-TAC

Meaningful Innovation.

WEEE Number: 80133970

MANUEL D'INSTRUCTIONS

LAMPE À ÉPI DE JARDIN SÉRIE EXTÉRIEUR

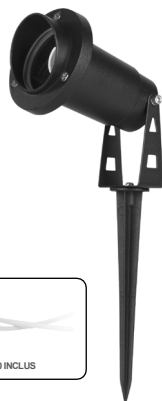

IP65
RATING

03
YEAR
WARRANTY*

DONNÉES TECHNIQUES

MODÈLE	VT-1126
SKU	10373
CHARGE NOMINALE	35W
BASE	GU10 (ampoule non incluse)
MATÉRIAU	Aluminium
DIMENSION	Ø75x106x245mm
TENSION D'ENTRÉE	AC : 220-240V, 50Hz

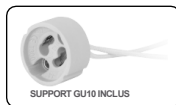

INTRODUCTION

Merci d'avoir choisi et acheté un produit V-TAC. V-TAC vous servira au mieux. Veuillez lire attentivement les instructions suivantes

avant de commencer l'installation et conservez ce manuel à portée de main pour pouvoir vous y référer ultérieurement. Si vous avez d'autres questions, veuillez contacter notre revendeur ou le vendeur local auprès duquel vous avez acheté le produit. Ils sont formés et prêts à vous servir au mieux. La garantie est valable pendant 3 ans à compter de la date d'achat. La garantie ne s'applique pas aux dommages causés par une installation incorrecte ou une usure anormale. L'entreprise ne garantit pas les dommages causés à toute surface par un démontage et une installation incorrects du produit. Les produits conviennent pour un fonctionnement quotidien de 10 à 12 heures. L'utilisation du produit pendant 24 heures par jour annule la garantie. Ce produit est garanti pour les défauts de fabrication uniquement.

ATTENTION !

1. Veillez à couper l'alimentation électrique avant de commencer l'installation.
2. L'installation ne doit être effectuée que par un électricien certifié.
3. Une mise à la terre correcte doit être assurée tout au long de l'installation.
4. La boîte étanche n'est pas incluse.



Ce marquage indique que ce produit ne doit pas être éliminé avec les autres déchets ménagers.



Attention, risque de choc électrique.

RoHS



SCHÉMA D'INSTALLATION :

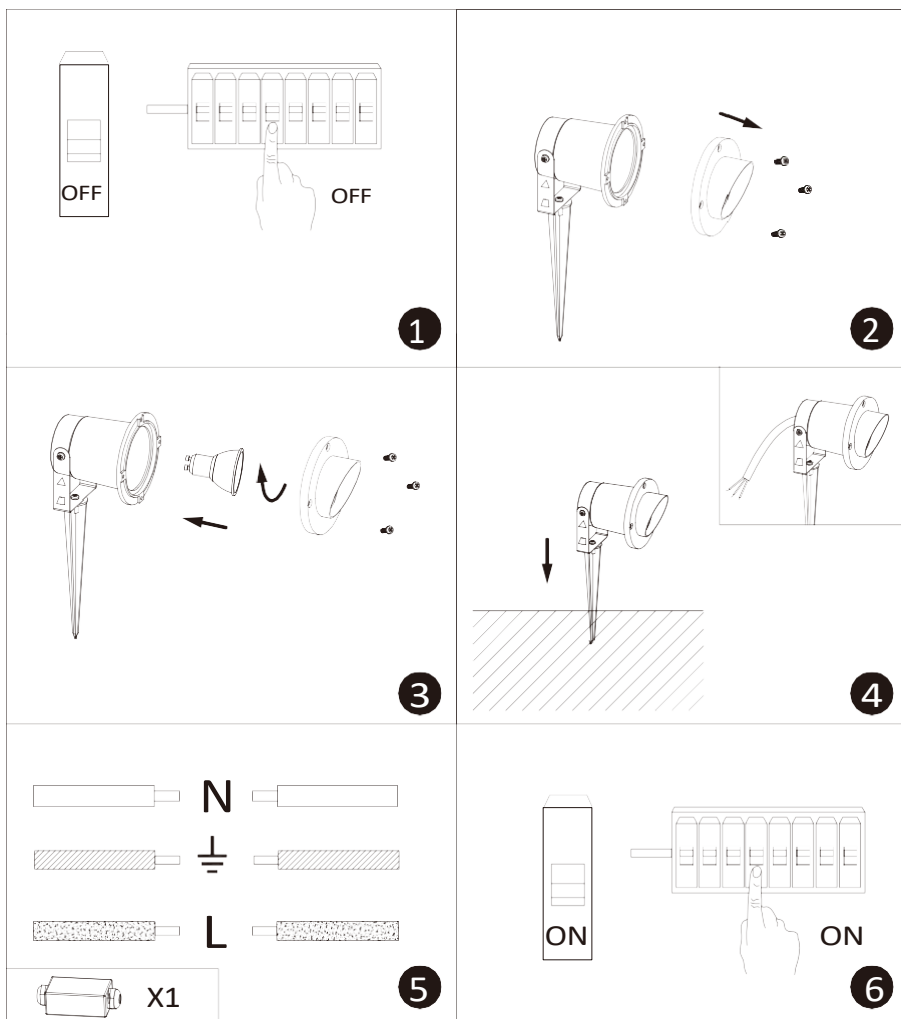

INSTRUCTIONS D'INSTALLATION

- Couper l'interrupteur d'alimentation.
- Retirer l'anneau avant de la lampe.
- Installer la source lumineuse (GU10).
- Assembler les lampes et les lanternes.
- Branchez l'alimentation électrique conformément au schéma.
- Mettez l'appareil sous tension si les étapes précédentes ont été effectuées correctement et sans erreur.

EN CAS DE QUESTION/PROBLÈME CONCERNANT LE PRODUIT, VEUILLEZ NOUS CONTACTER À L'ADRESSE SUIVANTE :
SUPPORT@V-TAC.EU. POUR PLUS D'INFORMATIONS SUR LA GAMME DE PRODUITS, VEUILLEZ CONTACTER NOTRE
DISTRIBUTEUR OU LES REVENDEURS LES PLUS PROCHES.

V-TAC EUROPE LTD. BULGARIA, PLOVDIV 4000, BUL.L.KARAVELOW 9B

V-TAC

Meaningful Innovation.

WEEE Number: 80133970

GEBRAUCHSANWEISUNG

GARTEN SPIKE LAMPE OUTDOOR SERIE

TECHNISCHE DATEN

MODELL	VT-1126
SKU	10373
BESTIMMTE BELASTUNG	35W
BASIS	GU10 (Glühbirne nicht enthalten)
MATERIAL	Aluminium
ABMESSUNG	Ø75x106x245mm
EINGANGSSPANNUNG	AC: 220-240V, 50Hz



**IP65
RATING**

**03
YEAR
WARRANTY***



EINFÜHRUNG

Vielen Dank, dass Sie ein V-TAC-Produkt ausgewählt und gekauft haben. V-TAC wird Ihnen die besten Dienste leisten. Bitte lesen Sie diese Anweisungen sorgfältig bevor Sie mit der Installation beginnen, und bewahren Sie dieses Handbuch zum späteren Nachschlagen auf. Sollten Sie weitere Fragen haben, wenden Sie sich bitte an unseren Händler oder den lokalen Verkäufer, bei dem Sie das Produkt gekauft haben. Sie sind geschult und bereit, Sie bestmöglich zu bedienen. Die Garantie gilt für 3 Jahre ab dem Kaufdatum. Die Garantie gilt nicht für Schäden, die durch unsachgemäße Installation oder abnormalen Verschleiß verursacht wurden. Das Unternehmen übernimmt keine Garantie für Schäden an Oberflächen, die durch unsachgemäßen Aus- und Einbau des Produkts entstehen. Die Produkte sind für einen täglichen Betrieb von 10-12 Stunden geeignet. Bei einer Nutzung des Produkts über 24 Stunden pro Tag erlischt die Garantie. Für dieses Produkt wird nur eine Garantie für Herstellungsfehler gewährt.

WARNUNG!

1. Bitte stellen Sie sicher, dass Sie den Strom abschalten, bevor Sie mit der Installation beginnen.
2. Die Installation sollte nur von einem zertifizierten Elektriker vorgenommen werden.
3. Die ordnungsgemäße Erdung sollte während der gesamten Installation gewährleistet sein.
4. Wasserdichte Box nicht enthalten.



Diese Kennzeichnung weist darauf hin, dass dieses Produkt nicht mit anderen Haushaltsabfällen entsorgt werden darf.



Vorsicht, Gefahr eines Stromschlags.

RoHS



INSTALLATIONSPLAN:

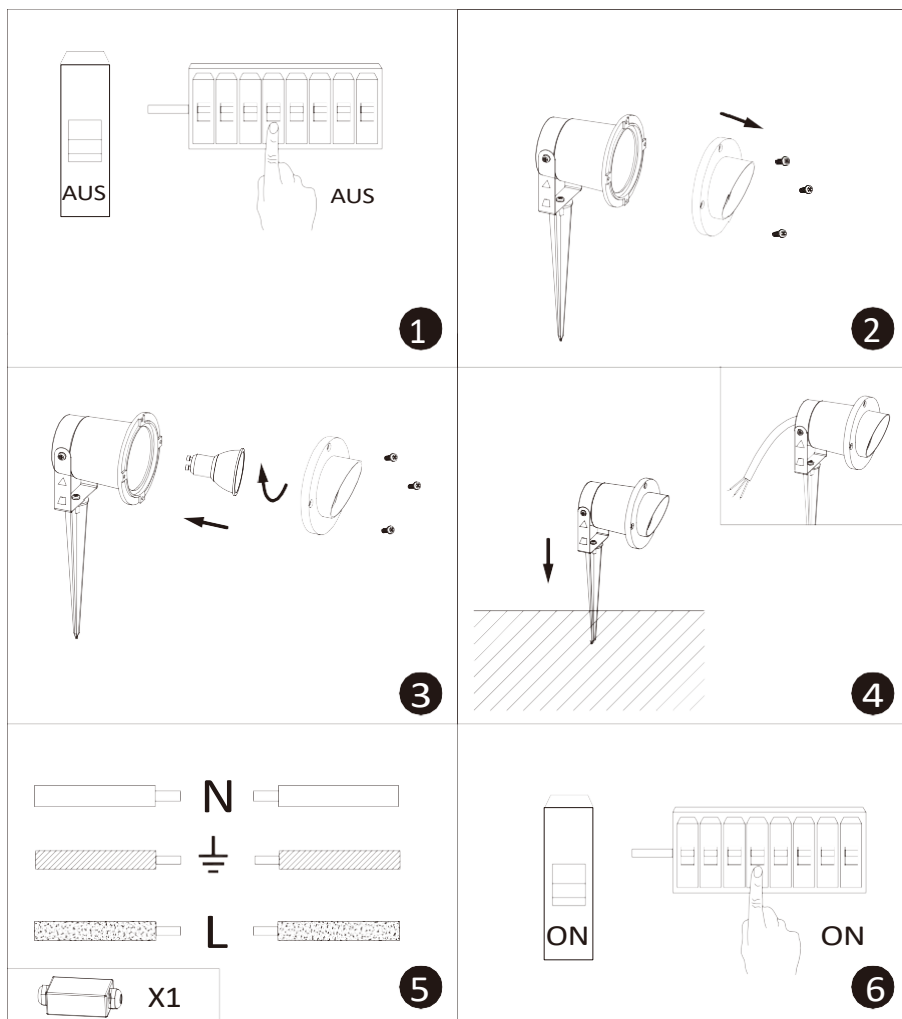

INSTALLATIONSANLEITUNG

- Schalten Sie den Netzschalter aus.
- Entfernen Sie den vorderen Ring der Leuchte.
- Installieren Sie die Lichtquelle (GU10).
- Bauen Sie die Lampen und Laternen zusammen.
- Schließen Sie das Gerät gemäß der Zeichnung an das Stromnetz an.
- Schalten Sie den Strom ein, wenn die oben genannten Schritte ordnungsgemäß und ohne Fehler durchgeführt wurden.

V-TAC

Meaningful Innovation.

WEEE Number: 80133970

ΕΓΧΕΙΡΙΔΙΟ ΟΔΗΓΙΩΝ

ΛΑΜΠΤΗΡΑΣ ΑΚΪΔΑΣ ΚΉΠΟΥ ΥΠΑΪΘΡΙΑ ΣΕΙΡΑ

ΤΕΧΝΙΚΑ ΣΤΟΙΧΕΙΑ

ΜΟΝΤΕΛΟ	VT-1126
SKU	10373
ΒΑΘΜΟΛΟΓΗΜ ΈΝΟ ΦΟΡΤΙΟ	35W
ΒΑΣΗ	GU10 (δεν περιλαμβάνεται ο λαμπτήρας)
ΥΛΙΚΟ	Αλουμίνιο
ΔΙΑΣΤΑΣΗ	Φ75x106x245mm
ΤΑΣΗ ΕΙΣΟΔΟΥ	AC: 220-240V, 50Hz

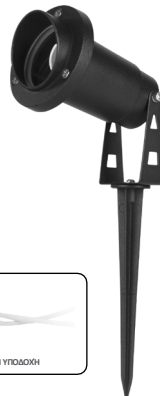

IP65
RATING

03
YEAR
WARRANTY*



ΕΙΣΑΓΩΓΗ

Σας ευχαριστούμε που επιλέξατε και αγοράσατε το προϊόν V-TAC. Η V-TAC θα σας εξυπηρετήσει με τον καλύτερο τρόπο. Παρακαλούμε διαβάστε προσεκτικά αυτές τις οδηγίες πριν ξεκινήσετε την εγκατάσταση και κρατήστε το παρόν εγχειρίδιο για μελλοντική αναφορά. Εάν έχετε οποιαδήποτε άλλη απορία, παρακαλούμε επικοινωνήστε με τον αντιπρόσωπο ή τον τοπικό πωλητή από τον οποίο αγοράσατε το προϊόν. Είναι εκπαιδευμένοι και έτοιμοι να σας εξυπηρετήσουν με τον καλύτερο δυνατό τρόπο. Η εγγύηση ισχύει για 3 χρόνια από την ημερομηνία αγοράς. Η εγγύηση δεν ισχύει για ζημιές που προκαλούνται από εσφαλμένη εγκατάσταση ή μη φυσιολογική φθορά. Η εταιρεία δεν παρέχει καμία εγγύηση για ζημιές σε οποιαδήποτε επιφάνεια λόγω λανθασμένης αφαίρεσης και εγκατάστασης του προϊόντος. Τα προϊόντα είναι κατάλληλα για 10-12 ώρες καθημερινής λειτουργίας. Η χρήση του προϊόντος για 24 ώρες την ημέρα θα ακυρώσει την εγγύηση. Αυτό το προϊόν φέρει εγγύηση μόνο για κατασκευαστικά ελαττώματα.

ΠΡΟΕΙΔΟΠΟΙΗΣΗ!

- Βεβαιωθείτε ότι έχετε απενεργοποιήσει το ρεύμα πριν ξεκινήσετε την εγκατάσταση.
- Η εγκατάσταση πρέπει να γίνεται μόνο από πιστοποιημένο ηλεκτρολόγο.
- Η σωστή γείωση πρέπει να εξασφαλίζεται σε όλη την εγκατάσταση.
- Το αδιάβροχο κουτί δεν περιλαμβάνεται.



Η σήμανση αυτή υποδεικνύει ότι το προϊόν αυτό δεν πρέπει να απορριπτεται μαζί με άλλα οικιακά απόβλητα.



Προσοχή, κίνδυνος ηλεκτροπληξίας.

RoHS



ΔΙΑΓΡΑΜΜΑ ΕΓΚΑΤΑΣΤΑΣΗΣ:

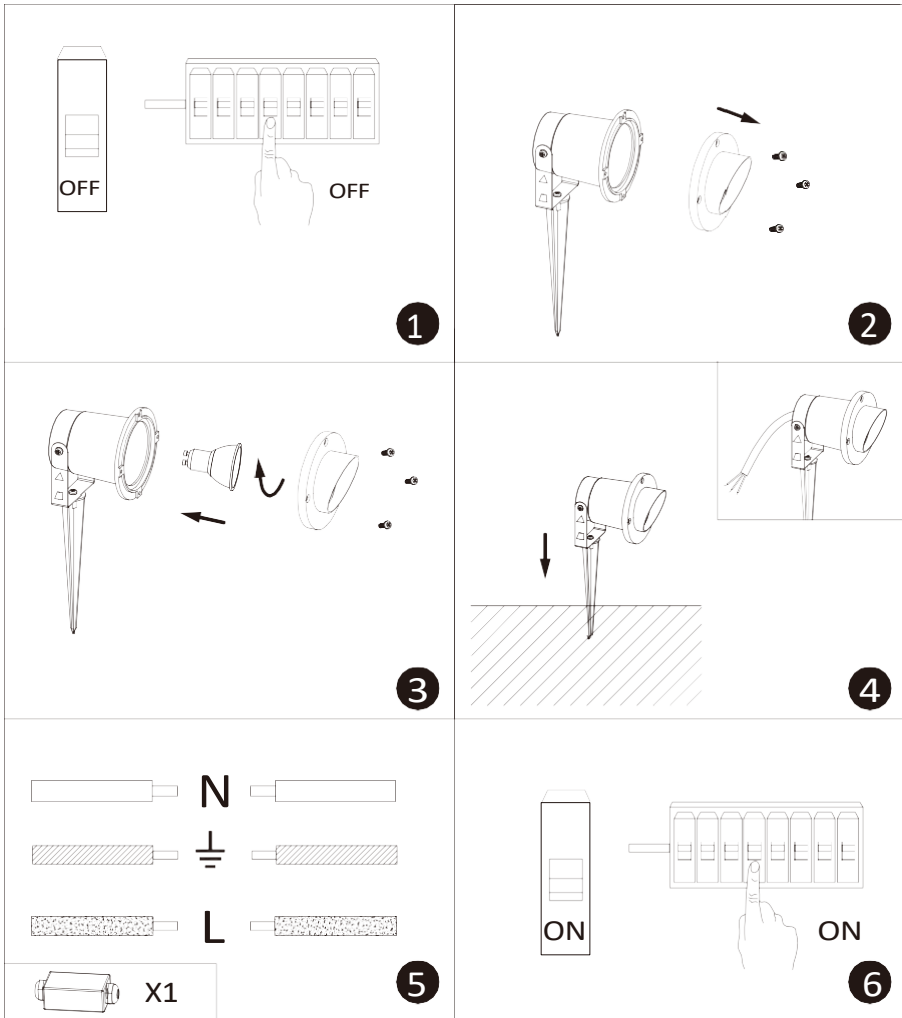

ΟΔΗΓΙΕΣ ΕΓΚΑΤΑΣΤΑΣΗΣ

- Κλείστε τον διακόπτη τροφοδοσίας.
- Αφαιρέστε τον μπροστινό δακτύλιο του λαμπτήρα.
- Τοποθετήστε την πηγή φωτός (GU10).
- Συναρμολογήστε τις λάμπες και τα φανάρια.
- Συνδέστε την παροχή ρεύματος σύμφωνα με το σχέδιο.
- Ενεργοποιήστε το ρεύμα αν τα παραπάνω βήματα έχουν γίνει σωστά και χωρίς λάθη.

V-TAC

Meaningful Innovation.

WEEE Number: 80133970

HASZNÁLATI ÚTMUTATÓ

KERTI TÜSKÉS LÁMPA KÜLTÉRI SOROZAT

TECHNIKAI ADATOK

MODELL	VT-1126
SKU	10373
NÉVEZETT TERHELÉS	35W
BASE	GU10 (az izzó nem tartozék)
ANYAG	Alumínium
DIMENZIÓ	Ø75x106x245mm
BEMENETI FESZÜLTÉS	AC: 220-240V, 50Hz



IP65
RATING

03
YEAR
WARRANTY*



BEVEZETÉS

Köszönjük, hogy V-TAC terméket választott és vásárolt. A V-TAC a legjobbat fogja nyújtani Önnek. Kérjük, olvassa el figyelmesen ezeket az utasításokat mielőtt elkezdene a telepítést, és tartsa kéznél ezt a kézikönyvet a későbbi használatra. Ha bármilyen más kérdése van, kérjük, forduljon a kereskedőnkhoz vagy a helyi forgalmazóhoz, akitől a terméket vásárolta. Ők képzettek és készen állnak arra, hogy a lehető legjobban kiszolgálják Önt. A garancia a vásárlástól számítót 3 évig érvényes. A garancia nem vonatkozik a helytelen telepítés vagy rendellenes elhasználódás okozta károokra. A vállalat nem vállal garanciát a termék helytelen eltávolítása és beszerelése miatt bármely felületen keletkezett károokra. A termékek napi 10-12 órás működésre alkalmasak. A termék napi 24 órás használata esetén a garancia érvényét veszti. A termékre kizárólag gyártási hibák esetén vállalunk garanciát.

FIGYELEM!

1. A telepítés megkezdése előtt feltétlenül kapcsolja ki a készüléket.
2. A beszerelést csak okleveles villanyszerelő végezheti.
3. Az egész telepítés során biztosítani kell a megfelelő földelést.
4. Vízálló doboz nem tartozék.



Ez a jelölés azt jelzi, hogy ez a termék nem ártalmatlanítható más háztartási hulladékkal együtt.



Vigyázat, áramütés veszélye.

RoHS



UK
CA

TELEPÍTÉSI DIAGRAM:

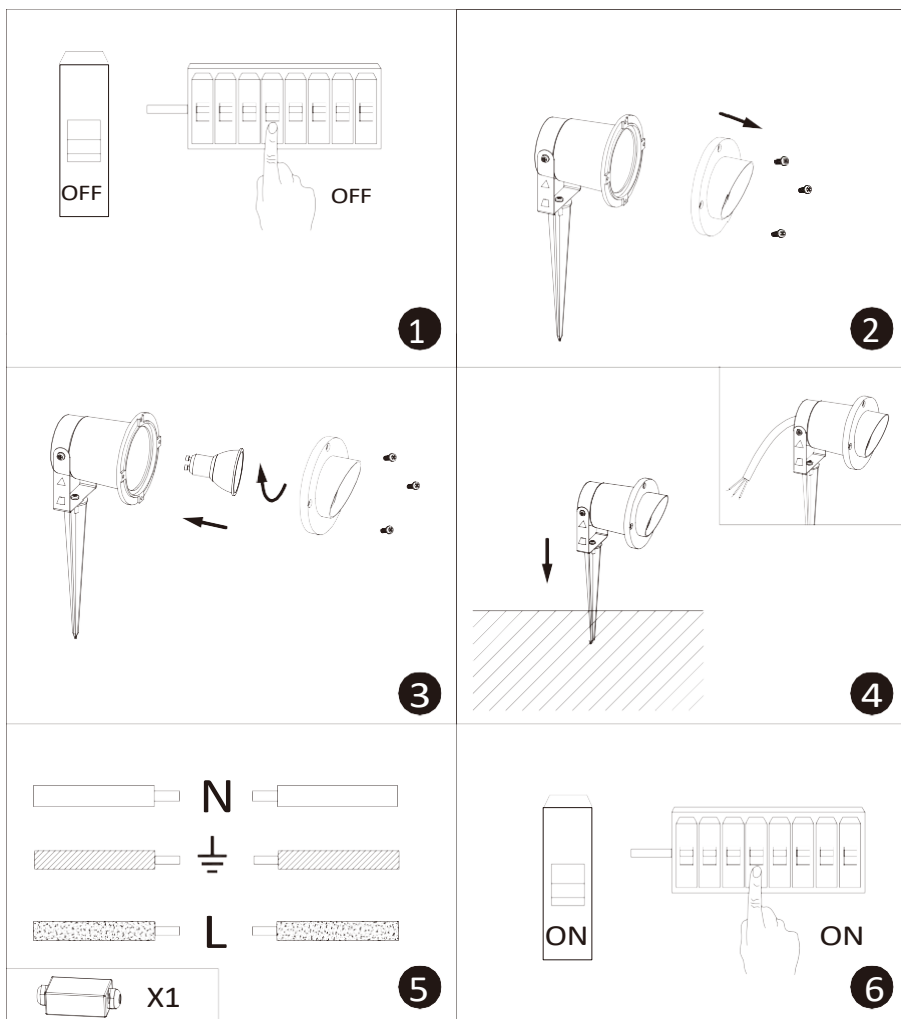

TELEPÍTÉSI UTASÍTÁS

- Kapcsolja ki a hálózati kapcsolót.
- Távolítsa el a lámpa első gyűrűjét.
- Szerelje be a fényforrást (GU10).
- Szerelje össze a lámpákat és a lámpásokat.
- Csatlakoztassa a tápegységhez a rajznak megfelelően.
- Kapcsolja be a készüléket, ha a fenti lépéseket hibátlanul elvégezte.

V-TAC

Meaningful Innovation.

WEEE Number: 80133970

MANUALE DI ISTRUZIONI

LAMPADA A SPILLO DA GIARDINO SERIE OUTDOOR

DATI TECNICI

MODELLO	VT-1126
SKU	10373
CARICO NOMINALE	35W
BASE	GU10 (lampadina non inclusa)
MATERIALE	Alluminio
DIMENSIONE	Ø75x106x245mm
TENSIONE D'INGRESSO	AC: 220-240V, 50Hz

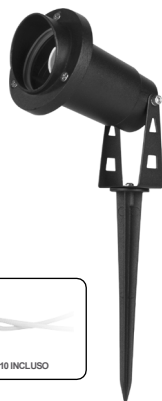

**IP65
RATING**

**03
YEAR
WARRANTY***



INTRODUZIONE

Grazie per aver scelto e acquistato un prodotto V-TAC. V-TAC vi servirà al meglio. Si prega di leggere attentamente le presenti istruzioni prima di iniziare l'installazione e tenere a portata di mano il presente manuale per future consultazioni. Per qualsiasi altra domanda, contattare il nostro rivenditore o il venditore locale presso il quale è stato acquistato il prodotto. Sono addestrati e pronti a servirvi al meglio. La garanzia è valida per 3 anni dalla data di acquisto. La garanzia non si applica ai danni causati da un'installazione non corretta o da un'usura anomala. L'azienda non fornisce alcuna garanzia contro i danni a qualsiasi superficie dovuti a un'errata rimozione e installazione del prodotto. I prodotti sono adatti per un funzionamento di 10-12 ore al giorno. L'utilizzo del prodotto per 24 ore al giorno invalida la garanzia. Questo prodotto è garantito solo per i difetti di fabbricazione.

ATTENZIONE!

1. Assicurarsi di spegnere l'alimentazione prima di iniziare l'installazione.
2. L'installazione deve essere eseguita esclusivamente da un elettricista certificato.
3. È necessario garantire una messa a terra adeguata per tutta la durata dell'installazione.
4. Scatola impermeabile non inclusa.



Questo marchio indica che questo prodotto non deve essere smaltito con altri rifiuti domestici.



Attenzione, rischio di scosse elettriche.

RoHS



SCHEMA DI INSTALLAZIONE:

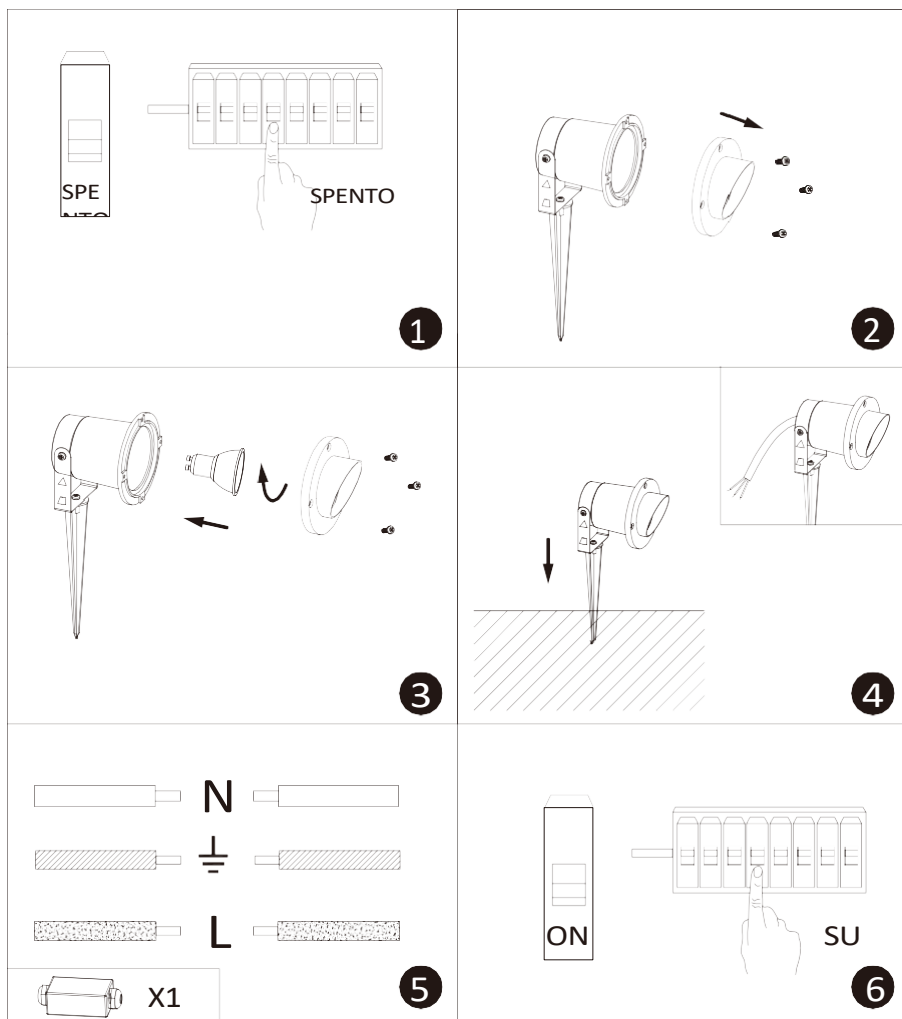

ISTRUZIONI PER L'INSTALLAZIONE

- Spegnerne l'interruttore di alimentazione.
- Rimuovere l'anello anteriore della lampada.
- Installare la sorgente luminosa (GU10).
- Assemblare le lampade e le lanterne.
- Collegare l'alimentazione secondo il disegno.
- Accendere l'alimentazione se i passaggi precedenti sono stati eseguiti correttamente senza errori.

IN CASO DI DOMANDE/PROBLEMI CON IL PRODOTTO, CONTATTATECI ALL'INDIRIZZO:
SUPPORT@V-TAC.EU PER ULTERIORI INFORMAZIONI SULLA GAMMA DI PRODOTTI, SI PREGA DI
CONTATTARE IL NOSTRO DISTRIBUTORE O I RIVENDITORI PIÙ VICINI.
V-TAC EUROPE LTD. BULGARIA, PLOVDIV 4000, BUL.L.KARAVELOW 9B

V-TAC

Meaningful Innovation.

WEEE Number: 80133970

INSTRUKCJA OBSŁUGI

OGRODOWA LAMPA KOLCZYSTA SERIA ZEWNĘTRZNA

DANE TECHNICZNE

MODEL	VT-1126
SKU	10373
OBCIĄŻENIE ZNAMIONOWE	35W
BASE	GU10 (żarówka nie wchodzi w skład zestawu)
MATERIAŁ	Aluminium
WYMIAR	Ø75x106x245mm
NAPIĘCIE WEJŚCIOWE	AC: 220-240 V, 50 Hz

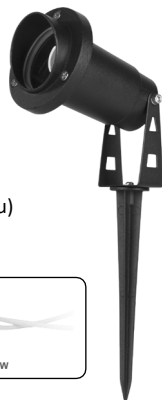

IP65
RATING

03
YEAR
WARRANTY*

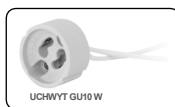

WPROWADZENIE

Dziękujemy za wybranie i zakup produktu V-TAC. V-TAC będzie służyć Ci jak najlepiej. Prosimy o uważne przeczytanie niniejszej instrukcji przed rozpoczęciem instalacji i zachować niniejszą instrukcję do wykorzystania w przyszłości. W przypadku jakichkolwiek innych pytań prosimy o kontakt z naszym dealerem lub lokalnym sprzedawcą, od którego zakupiono produkt. Są oni przeszkoleni i gotowi do świadczenia usług na najwyższym poziomie. Gwarancja jest ważna przez 3 lata od daty zakupu. Gwarancja nie obejmuje uszkodzeń spowodowanych nieprawidłową instalacją lub nadmiernym zużyciem. Firma nie udziela gwarancji na uszkodzenia powierzchni spowodowane nieprawidłowym demontażem i montażem produktu. Produkty są odpowiednie do pracy przez 10-12 godzin dziennie. Używanie produktu przez 24 godzin na dobę spowoduje utratę gwarancji. Ten produkt jest objęty gwarancją wyłącznie na wady produkcyjne.

OSTRZEŻENIE!

1. Przed rozpoczęciem instalacji należy wyłączyć zasilanie.
2. Instalacja powinna być wykonywana wyłącznie przez certyfikowanego elektryka.
3. Podczas całej instalacji należy zapewnić prawidłowe uziemienie.
4. Wodoodporne pudełko nie wchodzi w skład zestawu.



To oznaczenie wskazuje, że tego produktu nie należy wyrzucać razem z innymi odpadami domowymi.



Uwaga, ryzyko porażenia prądem.

RoHS



UK
CA

SCHEMAT INSTALACJI:

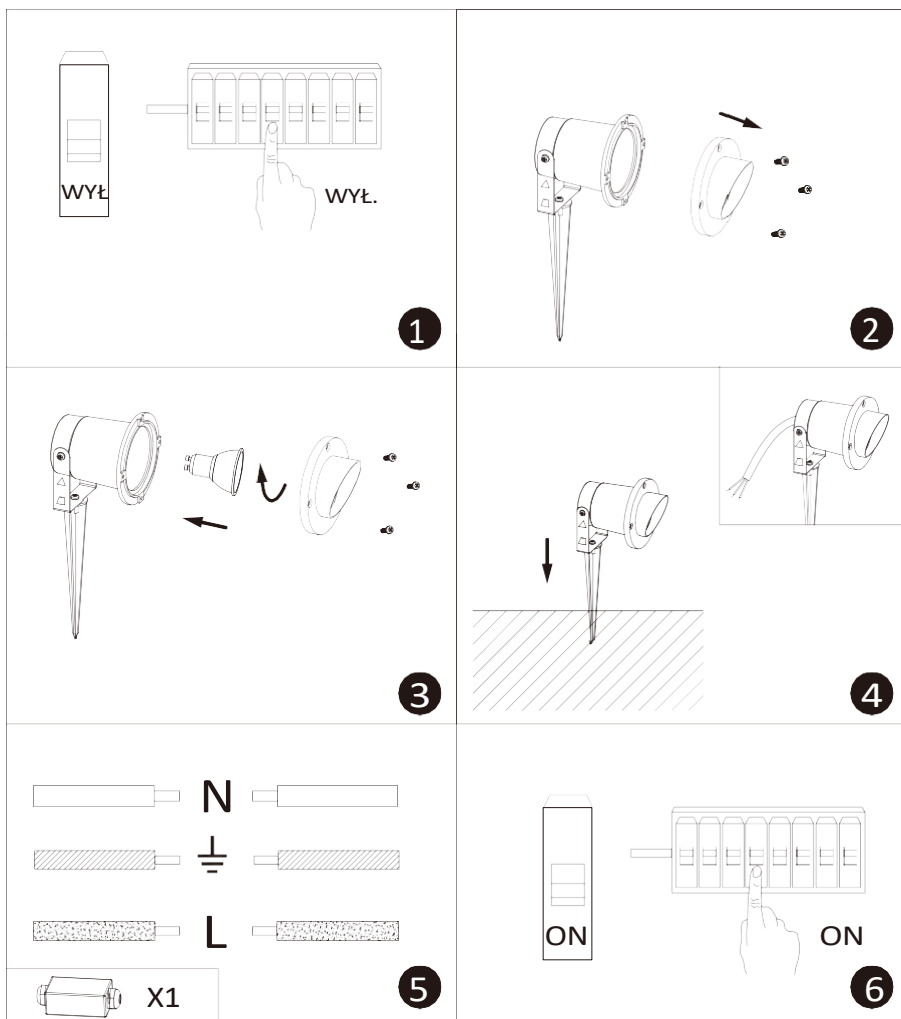

INSTRUKCJA INSTALACJI

- Wyłącz przelącznik zasilania.
- Zdejmij przedni pierścien lampy.
- Zainstaluj źródło światła (GU10).
- Zmontuj lampy i latarnie.
- Podłącz do zasilania zgodnie z rysunkiem.
- Włącz zasilanie, jeśli powyższe kroki zostały wykonane prawidłowo i bez błędów.

V-TAC

Meaningful Innovation.

WEEE Number: 80133970

MANUAL DE INSTRUÇÕES

CANDEEIRO DE JARDIM COM ESPIGÃO SÉRIE EXTERIOR

DADOS TÉCNICOS

MODELO	VT-1126
SKU	10373
CARGA NOMINAL	35W
BASE	GU10 (Lâmpada não incluída)
MATERIAL	Alumínio
DIMENSÃO	Ø75x106x245mm
TENSÃO DE ENTRADA	AC: 220-240V, 50Hz



IP65
RATING

03
YEAR
WARRANTY*



SUPORTE GU10 INCLUIDO

INTRODUÇÃO

Obrigado por selecionar e comprar o produto V-TAC. A V-TAC irá servi-lo da melhor forma. Por favor, leia atentamente estas instruções antes de iniciar a instalação e mantenha este manual à mão para referência futura. Se tiver qualquer outra dúvida, contacte o nosso revendedor ou o vendedor local a quem adquiriu o produto. Eles têm formação e estão prontos para o servir da melhor forma. A garantia é válida por 3 anos a partir da data de compra. A garantia não se aplica a danos causados por instalação incorrecta ou desgaste anormal. A empresa não dá qualquer garantia contra danos em qualquer superfície devido à remoção e instalação incorrectas do produto. Os produtos são adequados para um funcionamento diário de 10-12 horas. A utilização do produto durante 24 horas por dia anularia a garantia. Este produto tem garantia apenas para defeitos de fabrico.

ATENÇÃO!

1. Certifique-se de que desliga a alimentação eléctrica antes de iniciar a instalação.
2. A instalação só deve ser feita por um electricista certificado.
3. Deve ser assegurada uma ligação à terra adequada durante toda a instalação.
4. Caixa estanque não incluída.



Esta marcação indica que este produto não deve ser eliminado juntamente com outros resíduos domésticos.



Cuidado, risco de choque elétrico.

RoHS



ESQUEMA DE INSTALAÇÃO:

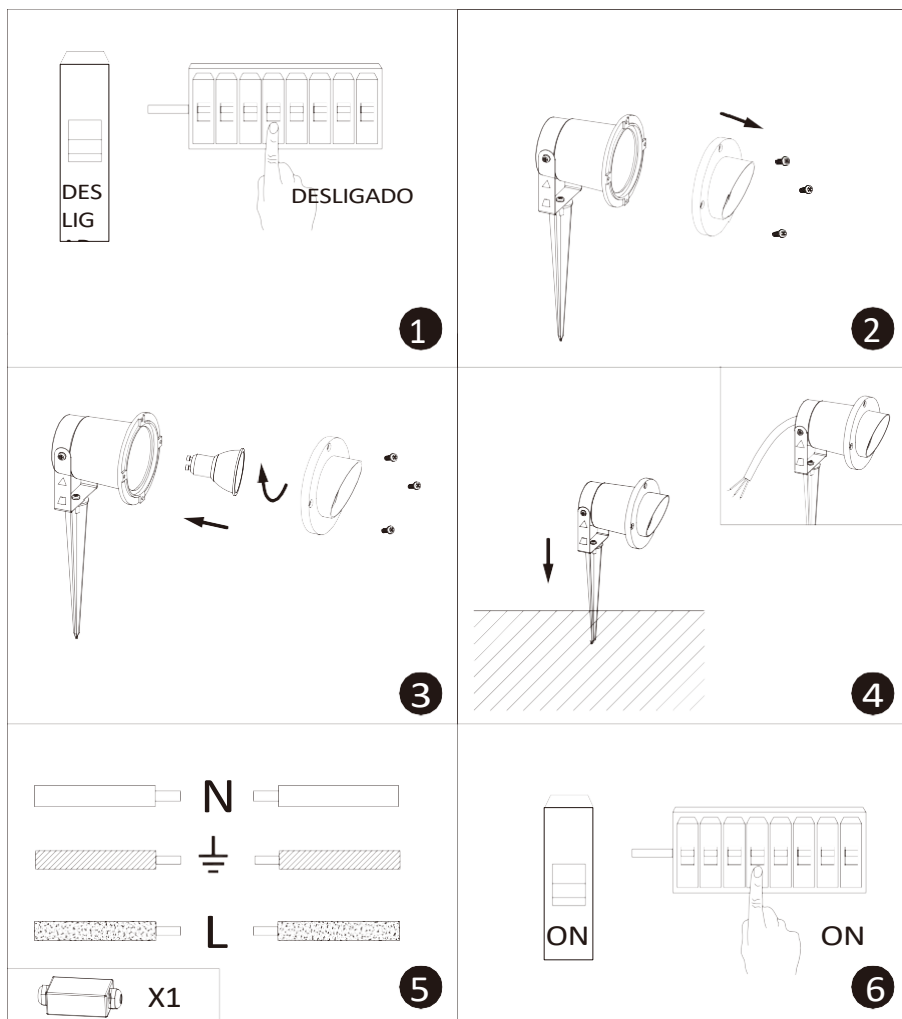

INSTRUÇÕES DE INSTALAÇÃO

- Desligar o interruptor de alimentação.
- Retirar o anel frontal da lâmpada.
- Instalar a fonte de luz (GU10).
- Montar os candeeiros e as lanternas.
- Ligar à alimentação eléctrica de acordo com o desenho.
- Ligar a alimentação se os passos anteriores tiverem sido efectuados corretamente e sem erros.

V-TAC

Meaningful Innovation.

WEEE Number: 80133970

MANUAL DE INSTRUCȚIUNI

LAMPĂ CU ȚEPI DE GRĂDINĂ SERIE PENTRU EXTERIOR

DATE TEHNICE

MODEL	VT-1126
SKU	10373
SARCINA NOMINALĂ	35W
BAZĂ	GU10 (becul nu este inclus)
MATERIAL	Aluminiu
DIMENSIUNE	Ø75x106x245mm
TENSIUNE DE INTRARE	AC: 220-240V, 50Hz



IP65
RATING

03
YEAR
WARRANTY*

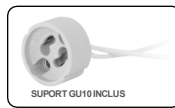

INTRODUCERE

Vă mulțumim pentru selectarea și cumpărarea produsului V-TAC. V-TAC vă va servi cel mai bine. Vă rugăm să citiți cu atenție aceste instrucțiuni înainte de a începe instalarea și păstrați acest manual la îndemână pentru consultare ulterioară. Dacă aveți orice altă întrebare, vă rugăm să contactați distribuitorul nostru sau vânzătorul local de la care ați achiziționat produsul. Aceștia sunt instruiți și pregătiți să vă servească la cel mai bun nivel. Garanția este valabilă timp de 3 ani de la data achiziției. Garanția nu se aplică daunelor cauzate de instalarea incorectă sau de uzura anormală. Compania nu oferă nicio garanție împotriva deteriorării oricărei suprafețe din cauză a îndepărtării și instalării incorecte a produsului. Produsele sunt potrivite pentru o funcționare de 10-12 Ore pe zi. Utilizarea produsului timp de 24 de ore pe zi ar anula garanția. Acest produs este garantat numai pentru defectele de fabricație.

AVERTISMENT!

- Vă rugăm să vă asigurați că opriți alimentarea înainte de a începe instalarea.
- Instalarea trebuie făcută numai de un electrician autorizat.
- Trebuie asigurată o împământare corespunzătoare pe întreaga durată a instalației.
- Cutia impermeabilă nu este inclusă.



Acest marcaj indică faptul că acest produs nu trebuie eliminat împreună cu alte deșuri menajere.



Atenție, risc de electrocutare.

RoHS



DIAGRAMA DE INSTALARE:

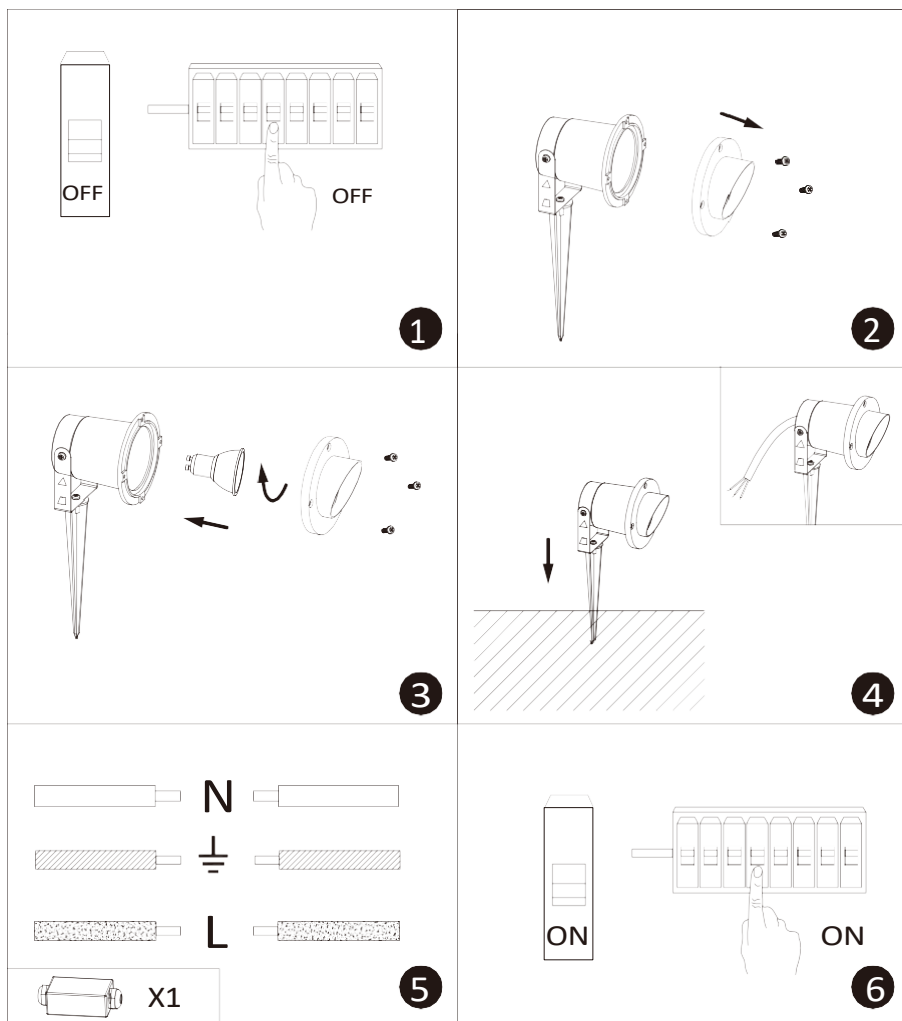

INSTRUCȚIUNI DE INSTALARE

- Oprii întrerupătorul de alimentare.
- Scoateți inelul frontal al lămpii.
- Instalați sursa de lumină (GU10).
- Asamblați lămpile și felinarele.
- Conectați la sursa de alimentare în conformitate cu desenul.
- Porniți alimentarea dacă pașii de mai sus sunt parcurși corect, fără nicio greșeală.

V-TAC

Meaningful Innovation.

WEEE Number: 80133970

MANUAL DE INSTRUCCIONES LÁMPARA DE PINCHO DE JARDÍN SERIE EXTERIOR

DATOS TÉCNICOS

MODELO	VT-1126
SKU	10373
CARGA NOMINAL	35W
BASE	GU10 (Bombilla no incluida)
MATERIAL	Aluminio
DIMENSIONES	Ø75x106x245mm
TENSIÓN DE ENTRADA	AC: 220-240V, 50Hz

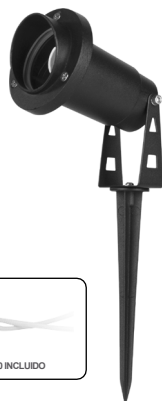

IP65
RATING

03
YEAR
WARRANTY*



INTRODUCCIÓN

Gracias por seleccionar y comprar un producto V-TAC. V-TAC le servirá lo mejor posible. Por favor, lea atentamente estas instrucciones

antes de iniciar la instalación y conserve este manual a mano para futuras consultas. Si tiene cualquier otra duda, póngase en contacto con nuestro distribuidor o vendedor local al que haya comprado el producto. Están formados y preparados para atenderle lo mejor posible. La garantía es válida durante 3 años a partir de la fecha de compra. La garantía no se aplica a los daños causados por una instalación incorrecta o un desgaste anormal. La empresa no ofrece ninguna garantía contra daños en cualquier superficie debidos a una incorrecta retirada e instalación del producto. Los productos son adecuados para un funcionamiento de 10-12 Horas diarias. El uso del producto durante 24 horas al día anularía la garantía. Este producto está garantizado únicamente por defectos de fabricación.

¡AVISO!

1. Asegúrese de desconectar la alimentación antes de iniciar la instalación.
2. La instalación sólo debe ser realizada por un electricista certificado.
3. Debe garantizarse una conexión a tierra adecuada en toda la instalación.
4. Caja estanca no incluida.



Esta marca indica que este producto no debe eliminarse con otros residuos domésticos.



Precaución, riesgo de descarga eléctrica.

RoHS



DIAGRAMA DE INSTALACIÓN:

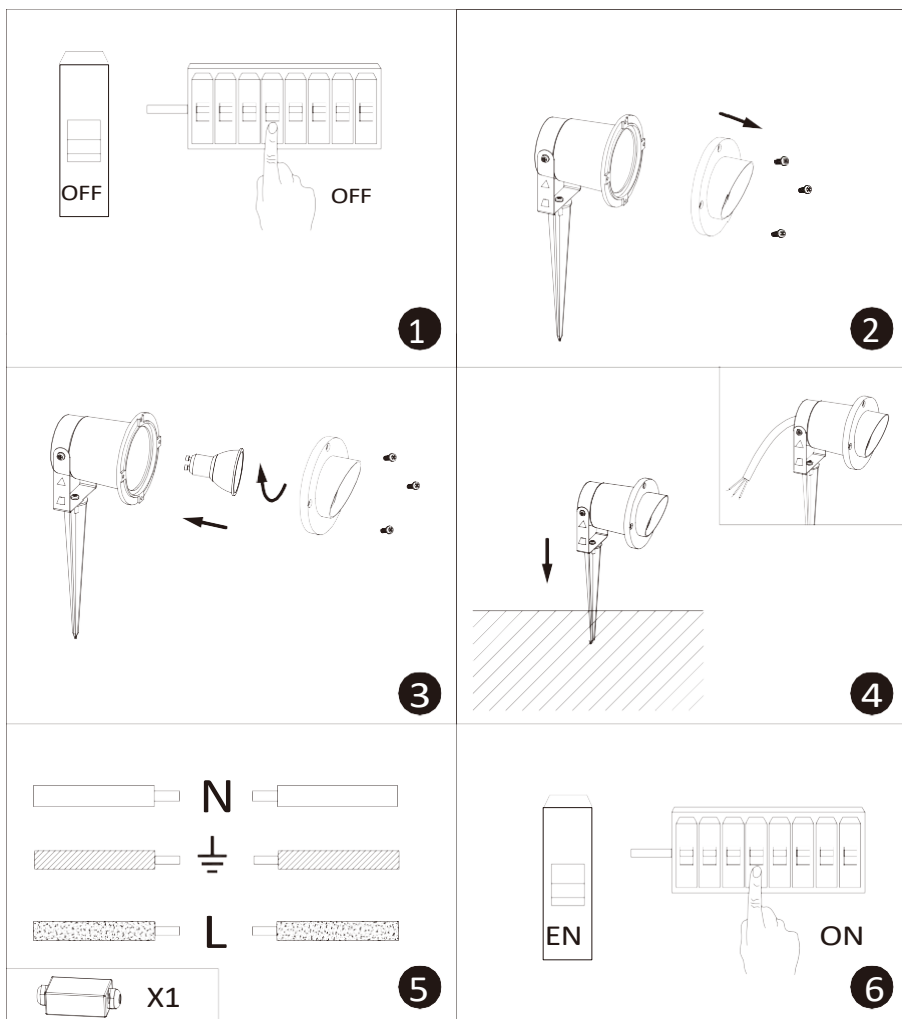

INSTRUCCIONES DE INSTALACIÓN

- Desconecta el interruptor de alimentación.
- Retire el anillo frontal de la lámpara.
- Instale la fuente de luz (GU10).
- Monta las lámparas y las linternas.
- Conéctelo a la fuente de alimentación según el dibujo.
- Conecte la alimentación si los pasos anteriores se han realizado correctamente y sin errores.